

VERSA-GARD®

EUROPA™
by VERSA-GARD®



EUROPA™

by VERSA-GARD®

The Pioneer in Advanced Food Protection Systems™

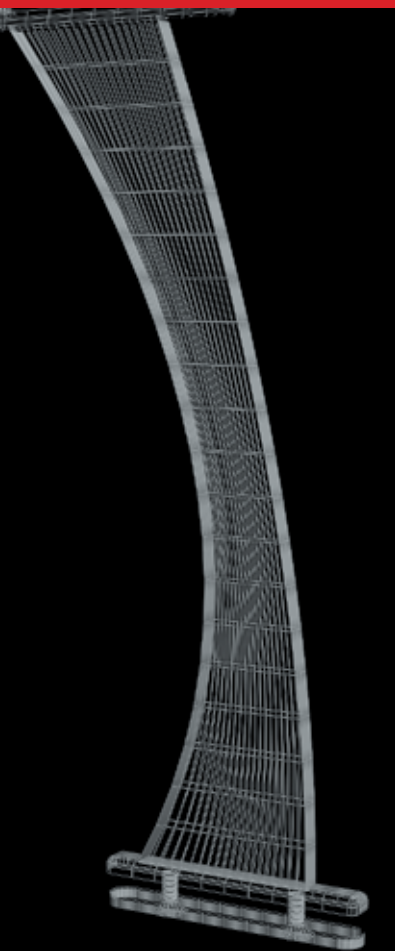

Key Features:

Concealed Mounting - no visible fasteners above drop-in assembly

6mm Bent Tempered Glass Panels

CNC Machined Supports & Hardware
All proudly Made in the USA

Available in Clear Anodized Aluminum, Brushed Aluminum, and Powder Coat finishes

VG7ZC MOUNTED ON 5 WELL DROP-IN



VG6B/C-EPS MOUNTED ON 5 WELL DROP-IN



VG5EC MOUNTED ON 5 WELL DROP-IN



Europa is offered exclusively through OEMs (Original Equipment Manufacturers). This elegant, patent-pending, Euro-style series of food protectors by Versa-Gard was developed to be factory-installed. Since OEMs are familiar with NSF2 guidelines and code requirements, the installation is guaranteed to be code compliant. This eliminates the need for on-site installation by a third party and relieves the owner/operator from the hassles associated with protectors mounted in improper locations.

Availability through OEMs offers several distinct advantages:

- One purchase
- One vendor
- One lead time
- One installation to coordinate
- NSF/ANIS 2 compliant

And eliminates:

- Costly on-site installation to countertops
- Relocating supports from improper installation
- Patching holes in countertop due to wrong placement

The Europa series was developed to mount directly to the flange of a drop-in assembly, eliminating the need for drilling holes in the countertop surface.

Europa food protectors may also be fastened to a countertop surface with concealed-mount hardware. The supports are through-bolted from the underside of the counter, assuring a clean appearance at every support location.



SERIES

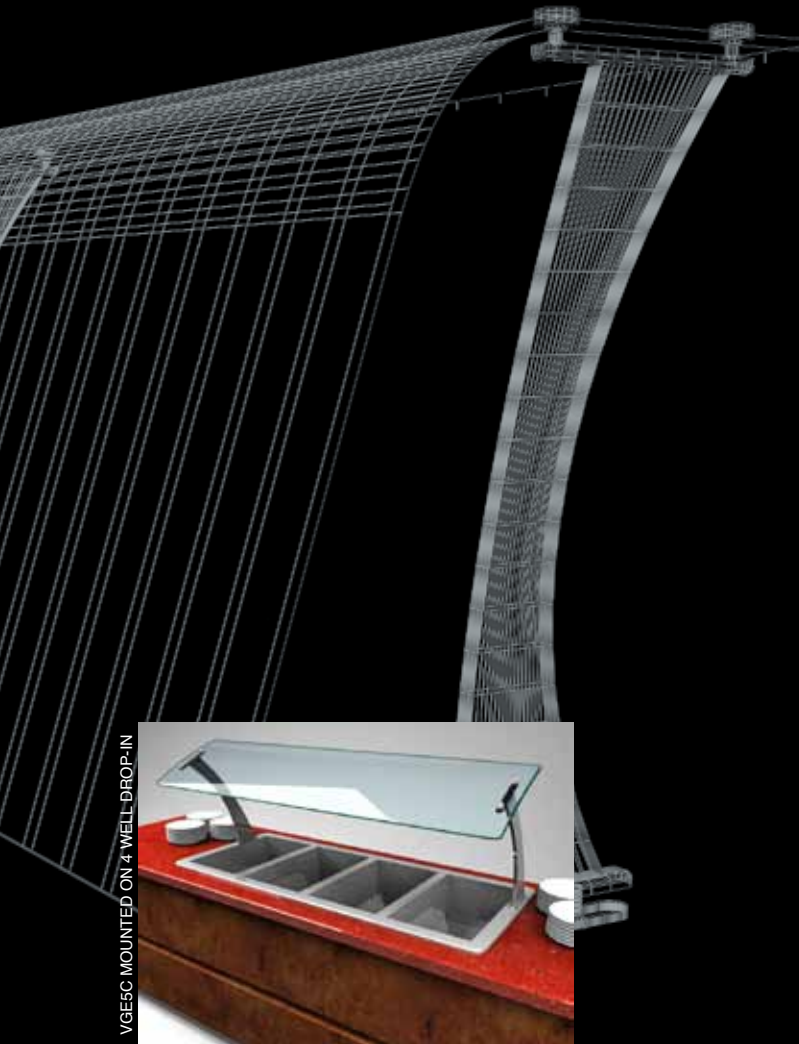

EUROPA SERIES Features:

Bent Tempered Glass Panels - Allows longer spans without need for center support structure.

Modularity - Offers options for intermediate shelving, side panels, and anti-reflective glass.

Multiple Finish Options - Clear Anodized Aluminum, Brushed Aluminum, Powder-Coated Aluminum (Color of your choice.)



Product boasts all the features inherent to **VERSA-GARD®** products

- Easy to Install
- Easy to Clean
- Easy to Disassemble for replacement of parts or add-on components
- One-Year Limited Warranty
- 100% CNC Machined Components - Proudly Made in the USA
- NSF/ANSI 2 Listed



Full Service Food Protector

6mm Clear Bent Tempered Glass Panel – 94” Maximum Span
 Side Return Panels available – (EP1) – 6mm Clear Tempered Glass
 Concealed Mounting Only

EUROPA
by VERSA-GARD



V P E C

Shown with optional **EP 1**

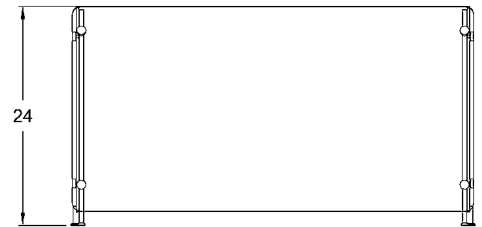
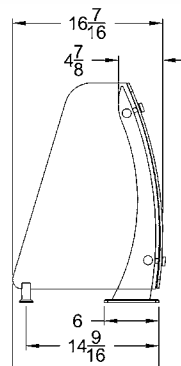

Self-Service Food Protector

6mm Clear Tempered Glass Panel – 48” Maximum Span
 10mm Clear Tempered Glass Panel – 60” Maximum Span
 12mm Clear Tempered Glass Panel – 72” Maximum Span
 Side Return Panels available – (EP2) – 6mm Clear Tempered Glass
 6” & 8” Intermediate Shelf Kit available – (SKE6 & SKE8)
 - Max. Span = 54” w/ 10mm Tempered Glass
 - Max. Span = 66” w/ 12mm Tempered Glass
 Concealed Mounting Only



V G E 5

Shown with optional **EP 2**

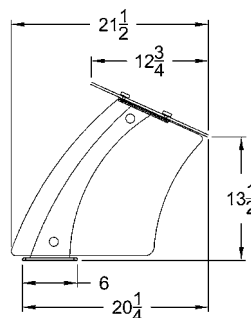



Self-Service Food Protector

6mm Clear Bent Tempered Glass Panel – 94" Maximum Span
 Side Return Panels available – (EP3) – 6mm Clear Tempered Glass
 6" & 8" Intermediate Shelf Kit available – (SKE6 & SKE8)
 - Max. Span = 54" w/ 10mm Tempered Glass
 - Max. Span = 66" w/ 12mm Tempered Glass
 Concealed Mounting Only

EUROPA
by VERSA-GARD



V G E 5 C

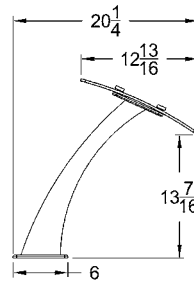

Double-Sided Self-Service Food Protector

6mm Clear Bent Tempered Glass Panels - 94" Maximum Span
 Side Return Panels available - (EP3DS) - 6mm Clear Tempered Glass
 Concealed Mounting Only



V G E 5 C - D S

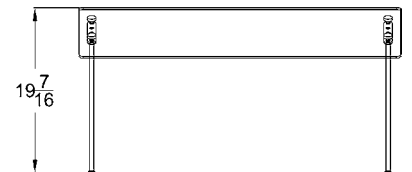
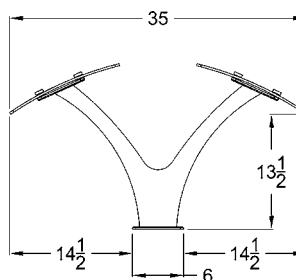



Self-Service Food Protector

6mm Clear Bent Tempered Glass Panel – 94" Maximum Span
 Side Return Panels available – (EP3) – 6mm Clear Tempered Glass
 6" & 8" Intermediate Shelf Kit available – (SKE6 & SKE8)
 - Max. Span = 54" w/ 10mm Tempered Glass
 - Max. Span = 66" w/ 12mm Tempered Glass
 Concealed Mounting Only

EUROPA
 by VERU-GARD



V G E 5 C

Shown with optional **S K E 8**

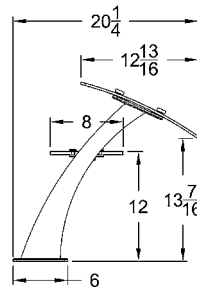

Full Service Food Protector w/ 12" Deep Top Shelf

6mm Clear Bent Tempered Glass Front Panel – 72" Maximum Span
 10mm Clear Tempered Glass Top Shelf – up to 60" Maximum Span
 12mm Clear Tempered Glass Top Shelf – up to 72" Maximum Span
 Side Return Panels available – (EP4) – 6mm Clear Tempered Glass
 6" & 8" Intermediate Shelf Kit available – (SKE6 & SKE8)
 - Max. Span = 54" w/ 10mm Tempered Glass
 - Max. Span = 66" w/ 12mm Tempered Glass
 Concealed Mounting Only

V G E 6 C

Shown with optional **E P 4**

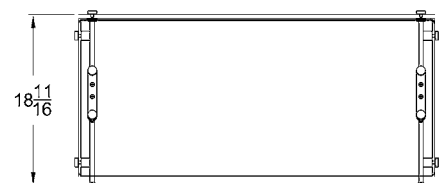
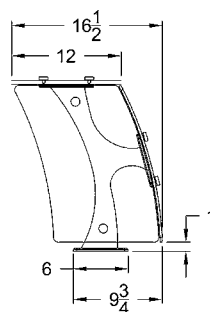



Full Service Food Protector w/ 9" Deep Top Shelf

6mm Clear Bent Tempered Glass Front Panel 90" Maximum Span
 Side Return Panels available – (EP5) – 6mm Clear Tempered Glass
 6" & 8" Intermediate Shelf Kit available – (SKE6 & SKE8)
 - Max. Span = 54" w/ 10mm Tempered Glass
 - Max. Span = 66" w/ 12mm Tempered Glass
 Concealed Mounting Only

*Minimum quantity of 10 units required per order for this product. Length of individual units and material finish of individual units may vary, but minimum quantity run of this product is 10 units.

EUROPA
 by VERSA-GARD



V G E 6 1 C

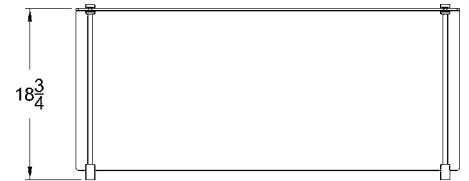
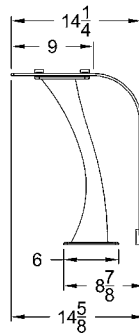

Full Service Food Protector w/ Sloped Top

6mm Clear Bent Tempered Glass Panels - 90" Maximum Span
 Side Return Panels available - (EP5.2) - 6mm Clear Tempered Glass
 6" & 8" Intermediate Shelf Kit available - (SKE6 & SKE8)
 - Max. Span = 54" w/ 10mm Tempered Glass
 - Max. Span = 66" w/ 12mm Tempered Glass
 Concealed Mounting Only

V G E 6 1 . 2 C

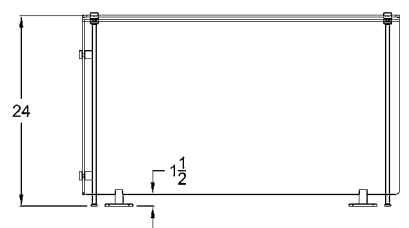
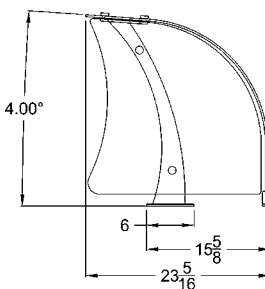



Full Service Food Protector w/ 7-1/2" Deep Top Shelf

6mm Clear Bent Tempered Glass Panels - 90" Maximum Span
 Side Return Panels available - (EP5.3) - 6mm Clear Tempered Glass
 6" & 8" Intermediate Shelf Kit available - (SKE6 & SKE8)
 - Max. Span = 54" w/ 10mm Tempered Glass
 - Max. Span = 66" w/ 12mm Tempered Glass
 Concealed Mounting Only

EUROPA
 by VERU-GARD



V G E 6 1 . 3 C

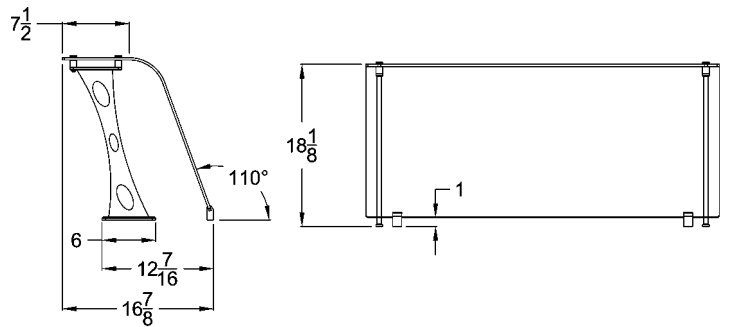

Full Service Food Protector w/ 8" Deep Top Shelf

6mm Clear Bent Tempered Glass Front Panel 94" Maximum Span
 Side Return Panels available - (EP6) - 6mm Clear Tempered Glass
 6" & 8" Intermediate Shelf Kit available - (SKE6 & SKE8)
 - Max. Span = 54" w/ 10mm Tempered Glass
 - Max. Span = 66" w/ 12mm Tempered Glass
 Concealed Mounting Only



V G E 6 2 C

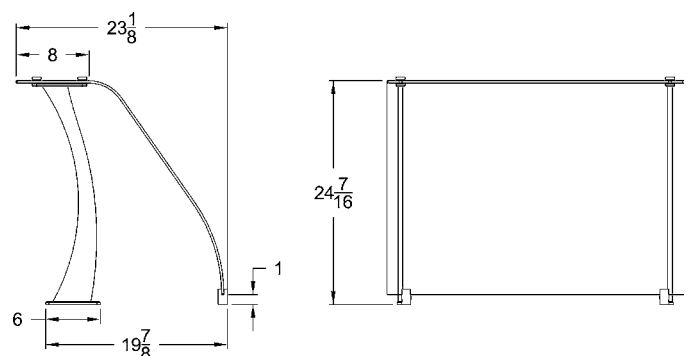



Self-Service Food Protector w/ 12" Deep Top Shelf

6mm Clear Bent Tempered Glass Front Panel 94" Maximum Span
Side Return Panels available – (EP7) – 6mm Clear Tempered Glass
6" & 8" Intermediate Shelf Kit available – (SKE6 & SKE8)

- Max. Span = 54" w/ 10mm Tempered Glass
 - Max. Span = 66" w/ 12mm Tempered Glass
- Concealed Mounting Only



V G E 7 C

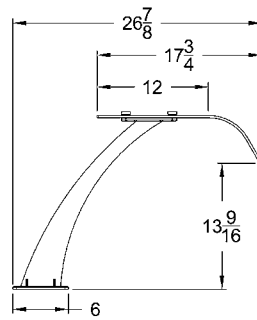

Double-Sided Self-Service Food Protector w/ Top

6mm Clear Bent Tempered Glass Panels - 94" Maximum Span
Side Return Panels available - (EP7DS) - 6mm Clear Tempered Glass
Concealed Mounting Only



V G E 7 C - D S

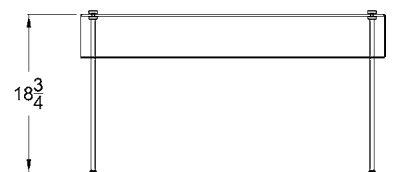
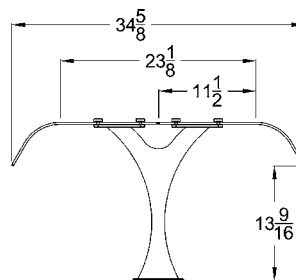



Self-Service Food Protector w/ 12" Deep Top Shelf

6mm Clear Bent Tempered Glass Front Panel 94" Maximum Span
 Side Return Panels available – (EP7) – 6mm Clear Tempered Glass
 6" & 8" Intermediate Shelf Kit available – (SKE6 & SKE8)

- Max. Span = 54" w/ 10mm Tempered Glass
 - Max. Span = 66" w/ 12mm Tempered Glass
- Concealed Mounting Only

EUROPA
by VERBA-GARD

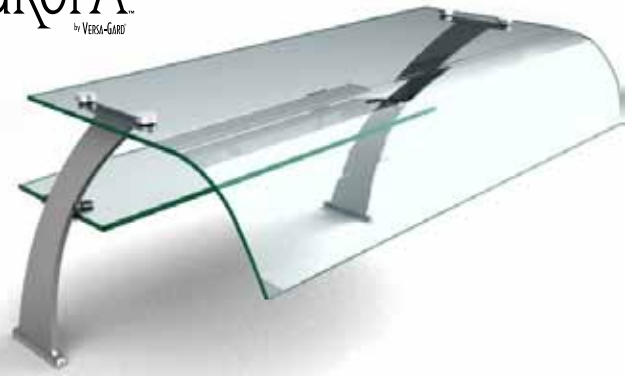

V G E 7 C

Shown with optional S K E 8

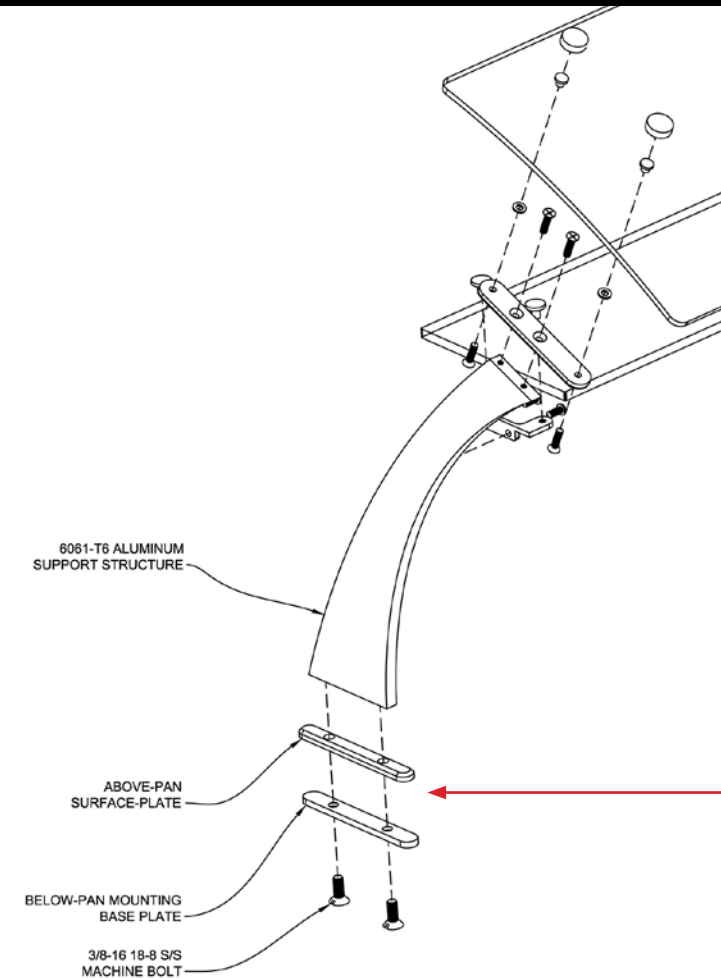
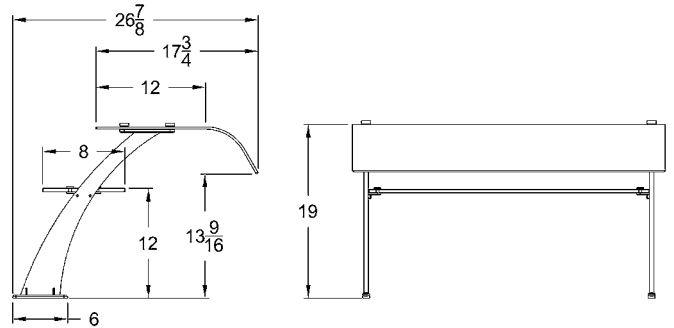

M O U N T I N G

DETAILS
 Patent Pending



OPTIONS:

SHELF KITS:

SKE6 – 6" deep shelf kit:

10mm for 54" Maximum Span

12mm for 66" Maximum Span

SKE8 – 8" deep shelf kit:

10mm for 54" Maximum Span

12mm for 66" Maximum Span

END PANELS:

EP1 - for model VPEC

EP2 - for model VGE5

EP3 - for model VGE5C

EP3DS - for model VGE5C-DS

EP4 - for model VGE6C

EP5 - for model VGE61C

EP5.2 - for model VGE61.2C

EP5.3 - for model VGE61.3C

EP6 - for model VGE62C

EP7 - for model VGE7C

EP7DS - for model VGE7C-DS

EP8 - for model VGE6

EUROPA™

by VERSA-GARD®



VERSA-GARD®

EUROPA™
by VERSA-GARD

SlimLine™
by VERSA-GARD

EXO™
Patent Pending by VERSA-GARD

EXO^{G2}™
by VERSA-GARD

GARDIAN™
by VERSA-GARD



Distributed by:

VERSA-GARD®

Copyright © 2010 Versa-Gard® All rights reserved.



Ph: 678•730•4155
Fax: 678•730•4160
www.versa-gard.com
012710